

NETZSCH

Proven Excellence.



Simultaneous Thermal Analysis STA 509 *Jupiter*® Series

Method, Technique, Applications

Analyzing & Testing



The ORIGINAL:
From one of the first STAs
on the market to today's
best-performing STAs

Flexible, Sophisticated & Technically Outstanding

Simultaneous Thermal Analysis generally refers to the simultaneous application of Thermogravimetry (TGA) and Differential Scanning Calorimetry (DSC) to one and the same sample in a single instrument. The advantages are obvious: The test conditions are perfectly identical for the TGA and DSC signals and include:

- Atmosphere
- Gas flow rate
- Vapor pressure on the sample
- Heating rate
- Thermal contact to the sample crucible
- Sensor radiation effect, etc.

Furthermore, sample throughput is improved as more information can be gathered from each test run. The STA 509 *Jupiter*[®] series is compliant to several relevant standards.

DSC Possibilities

- Specific heat capacity
- Melting/crystallization behavior
- Solid-solid transitions
- Polymorphism
- Glass transitions
- Degree of crystallinity
- Oxidative stability
- Cross-linking reactions
- TM-DSC
- Purity determination
- Kinetics simulations
- Thermal simulations

TGA Possibilities

- Mass changes
- Decomposition
- Oxidation/reduction behavior
- Temperature stability
- Compositional analysis
- Corrosion studies
- Kinetics simulations
- Thermal simulations

The STA 509 *Jupiter*[®] Series

Outstanding Performance Coupled with Cutting-Edge Design

MODULAR DESIGN FOR SEAMLESS CUSTOMIZATION

The STA's modular design allows for easy exchange of furnaces and sensors to accommodate multiple applications over a wide temperature range from -150°C to 2400°C.

TOP-LOADING BALANCE DESIGN

The top-loading and electronic compensated design offers ideal performance and easy handling, making it the obvious choice for a flexible analytic system and evolved gas analysis.

OPTIMIZED EFFICIENCY FOR MORE SUSTAINABILITY

The combination of electronic thermal stabilization and the Eco Mode feature ensures peak performance while minimizing energy and gas consumption for significant savings.



DEFINED ATMOSPHERIC CONDITIONS

The vacuumtight design and meticulous control of gas flows allow precise handling of high-purity atmospheres with respect to various inert, oxidizing, reducing and corrosive gases.

PRECISION AND ACCURACY

The combination of a nano-gram balance and a high performance heat-flux DSC provides exceptional accuracy with minimal drift and unmatched flexibility with high sample loads.

ACCESSORIES AND EVOLVED GAS ANALYSIS

Extensive accessories, including humidity and water vapor generators, broaden the application possibilities. Furthermore, the integration of Evolved Gas Analysis with MS, FT-IR, or GC-MS systems significantly enhances the analytical potential of the STA 509 *Jupiter*[®] series.

The STA 509 *Jupiter*[®] Series

Classic

Discover Our Range
of Carefully Tailored
Simultaneous
Thermal Analyzers,
Each Designed to
Meet Different
Customer Needs

The STA 509 *Jupiter*[®]
*Classic, Select and
Supreme*

- RT to 1600°C
- SiC furnace
- Balance resolution: 0.1 µg
- Optional 20-position ASC



Best Price/Performance Ratio

Known for its exceptional price/performance ratio, the *Classic* is the perfect choice for routine analysis. The high-performance SiC furnace offers a temperature range from room temperature to 1600°C on the sample. Its high load balance and DSC capability make it ideal for all typical STA applications – a great choice at a great price.

Select

- -150°C to 2400°C
- Choice of 12 different furnaces
- Balance resolution: 0.1 µg
- Optional 20-position ASC or 2nd furnace



Broadest Temperature Range, Largest Selection of Accessories

The *Select* version offers unmatched versatility, allowing an ideal configuration to meet your individual needs for both hardware and software. With the flexibility provided by different user-interchange furnace and sensor options, the broad temperature range from -150°C to 2400°C, and high-sensitivity heat-flow DSC capability, this system is suitable for the analysis of nearly all kinds of materials. Its adaptability makes it an indispensable tool for industrial and academic research, ensuring optimal performance across diverse applications.

Supreme

- -150°C to 2000°C
- Choice of 9 different furnaces
- Balance resolution: 0.025 µg
- Optional 20-position ASC or 2nd furnace



Exceptional Balance Resolution, High Long-Term Stability

The *Supreme* version represents the pinnacle of the STA 509 Jupiter® series, seamlessly integrating top-loading convenience with unparalleled precision. Boasting a balance resolution as fine as 25 ng along with long-term stability, it is tailored to surpass the most demanding standards in both hardware and software. The *Supreme* stands out as an indispensable instrument for cutting-edge research and development, where only the utmost in precision and reliability are sufficient.

The Appropriate Furnace for Your Application

Various interchangeable furnaces are available to accommodate different application areas over the entire temperature range (-150°C to 2400°C). A double furnace hoist allows for the simultaneous installation of two different furnaces for improved sample throughput or for low- and high-temperature tests with the same instrument. The furnaces can easily be changed out by the operator. Therefore, the system is adaptable to any future application range.

Day-to-Day Workhorse

The silicon carbide furnace, the robust workhorse of the STA 509 *Jupiter*[®], operates from ambient to 1600°C. Equipped with an aluminum oxide protective tube, it handles aggressive samples and corrosive atmospheres. Its user-friendly design allows for easy tube replacement by operators, ensuring minimal downtime.

Top-Notch Furnace Performance

The platinum and rhodium furnaces are designed with highest performance in mind. The precisely crafted metal-based heated systems ensure excellent furnace performance and deliver precise and reliable results for demanding tasks, such as determining specific heat capacity even at higher temperatures.

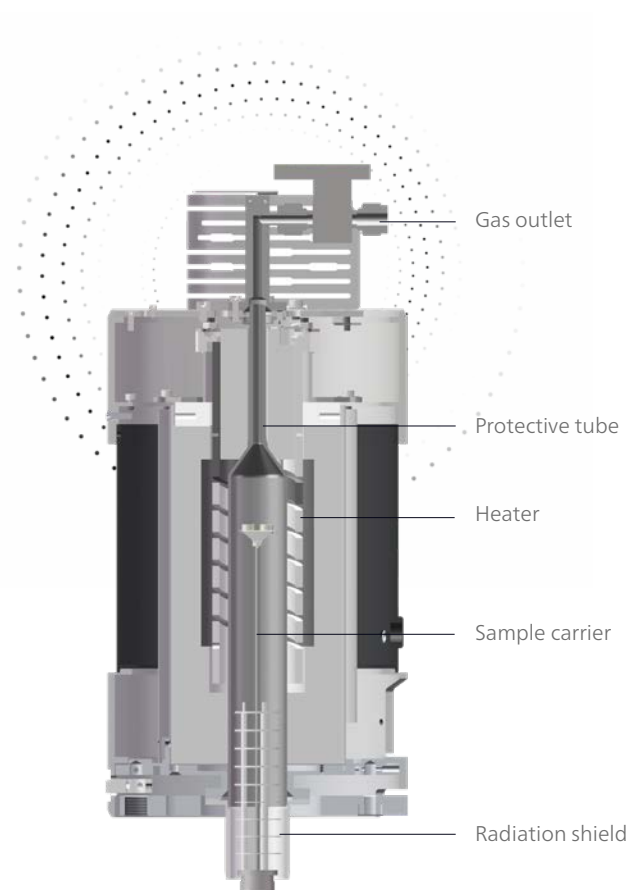

SiC furnace



Furnace type	Temperature range	Cooling system
Silicon carbide	RT to 1600°C	Passive cooling
Platinum	RT to 1500°C	Passive cooling
Rhodium	RT to 1650°C	Passive cooling

Measurements to the Highest of Temperatures

The graphite and especially the tungsten furnaces are capable of reaching temperatures of up to 2400°C, facilitating analysis of material characteristics and stabilities in environments of extreme thermal conditions. This capability enables comprehensive exploration of high-temperature applications such as ceramics, metals and refractories.

Your Results Achieved at the Highest Speed

The high-speed furnace allows for the simulation of realistic heating processes with linear heating rates up to 1000 K/min. This can be useful when imitating industrial processes, such as the production of metallic glasses or high-performance metals and alloys.

Measurements Down to the Lowest of Temperatures

The silver and steel furnaces enable measurements in the sub-ambient temperature range by utilizing an active cooling system. The silver furnace excels in DSC performance, like specific heat capacity, while the steel furnace covers a larger temperature range from -150°C to 1000°C.



STA 509 Jupiter®
Select with tungsten
furnace and SiC
furnace



Furnace type	Temperature range	Cooling system
Silver	-120°C to 675°C	Liquid nitrogen*
Steel	-150°C to 1000°C	Liquid nitrogen*
High-speed	RT to 1250°C	Passive cooling
Graphite	RT to 2000°C	Tap or chilled water
Tungsten	RT to 2400°C	Tap or chilled water

* Alternative vortex cooling allows for start temperatures around 0°C

Solutions for Special Applications

Gas Analysis of High-Boiling Vapors

The *SKIMMER* furnace can be coupled directly to the MS gas analyzer, thus ensuring the shortest possible path for gas transfer. Its dual-step pressure reduction, at the same temperature as the furnace, mitigates condensation risks, thereby improving detection sensitivity. Crafted from high-temperature materials, the *SKIMMER* operates efficiently at temperatures to 1950°C, making it suitable for demanding tasks in the field of evolved gas analysis, including metal or salt vapor analysis, as well as the examination of high-boiling organics.

Corrosive Atmospheres

For working in critical atmospheres, a “corrosive gas version” of the STA 509 *Jupiter*® can be supplied. This version is optimized for measurements under corrosive atmospheres such as reducing ones.

Humid Atmospheres up to 100% Water Vapor Concentration

The copper and water-vapor furnaces are engineered to be able to measure under humid atmospheres. Both systems incorporate supplementary heaters to prevent water condensation, ensuring reliable performance even under high dew point conditions, with up to 100% water concentration in the atmosphere. The copper furnace is equipped with an active cooling system for precise, long-term temperature control, even at room temperature or below, while the water-vapor furnace offers a broader temperature range of up to 1250°C for high-temperature applications.

Software Controlled Gas Switch

When measuring in a humid atmosphere with the vapor or copper furnace, the gas switch valve system (GSV 500) allows switching between humid and dry atmospheres during a measurement.



STA 509 *Jupiter*® with water vapor furnace, GSV 500 and water vapor generator



Furnace type	Temperature range	Cooling system
Water-vapor	RT to 1250°C	Passive cooling
Copper (Humidity)	-150°C to 500°C	Liquid nitrogen*
SiC- <i>SKIMMER</i>	RT to 1450°C	Passive cooling
Graphite- <i>SKIMMER</i>	RT to 1950°C	Tap or chilled water

* Alternative vortex cooling allows for start temperatures around 0°C



MEET YOUR NEEDS WITH THE RIGHT SENSOR

Various Sensors

The STA 509 *Jupiter*® series features an interchangeable sensor system that offers unparalleled versatility and adaptability in experimental setups. This capability allows researchers to tailor their testing approaches to match specific sample characteristics, environmental conditions, and research objectives.

The Quick-Connect feature permits sensor changes to be made in seconds, ensuring seamless adaptation of the system to different potential applications, ultimately maximizing the utility and effectiveness of the testing system.

Sensor Thermocouples

We offer different thermocouples (S, P, E, K, W, etc.) suitable for most applications. For further information, see our accessories catalogue.

TGA-DSC and TGA-DSC (c_p) sensors provide quantitative DSC testing in addition to TGA results, enabling comprehensive thermal analysis. In particular, the c_p versions allow for highly accurate determination of the specific heat capacity, improving the accuracy of thermal measurements.

TGA-DTA sensors offer simultaneous measurement of weight changes and qualitative energetic effects, perfect for routine tests at an effective cost. In addition, TGA-DTA technology is adaptable to operating under extreme conditions, such as corrosive atmospheres or temperatures reaching up to 2400°C.

The TGA sensor enables precise measurement of mass changes combined with remarkable versatility to accommodate different sample shapes and volumes. Special versions with suspended or net-shaped sample supports are available to optimize sample-gas interactions for efficient analysis.





Thermal Analysis Made More Sustainable

STA 509 *Jupiter*[®] Eco Mode

To obtain accurate thermogravimetric results with low drift behavior, most manufacturers have to resort to thermostatic control using a water circuit. Having to continuously run the thermostat consumes a lot of energy and produces waste heat, which subsequently needs to be regulated by air conditioning.

NETZSCH has succeeded in eliminating the external thermostat. The temperature of the weighing chamber is now controlled electronically while maintaining excellent temperature stability. By eliminating the thermostat, the energy consumption of an STA 509 *Jupiter*[®] for an average user is reduced by 70%*, which translates into a savings of 5,000 KW/h of electricity per year. Another way to run the unit more economically is to use the Eco Mode, which turns off the gases when they are not needed. All this makes the unit cheaper to run and effortlessly reduces your carbon footprint.

To make it even more sustainable, we offer predictive maintenance, an optional lifetime warranty, and long-term parts availability.

Further Advantages of the STA Eco Mode are:

- Less waste heat
- Saves space
- Predictive maintenance
- Best performance

* when using the instrument 3 times a day on 250 days a year

70% LESS ENERGY AND COST –
NO EXTERNAL TEMPERATURE CONTROL NEEDED

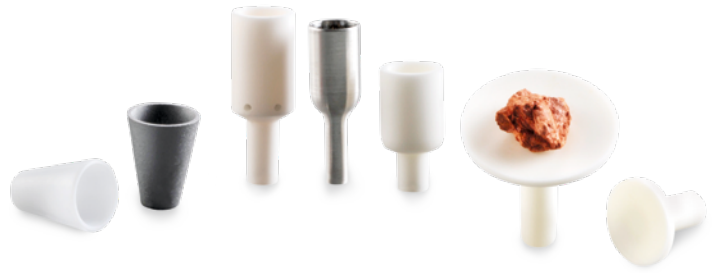

Automatic Sample Changer

An automatic sample changer for up to 20 samples is optionally available. The sample changer is designed for optimum crucible placement and maximum throughput. Preprogramming allows measurements to be carried out during the night or weekend. The software can automatically carry out analyses using automatic or predefined evaluations.

Crucibles

Explore the possibilities of materials science with our wide range of crucibles. Made of premium materials such as highly sintered ceramics, refined metals, and pure graphite, our crucibles ensure reliability for measurements on challenging materials such as high-melting alloys, molten salts, refractory materials, and more. Perforated crucibles or net shaped sample holder geometries enable an optimized contact of reactive gases with the sample.

Accessories



Automatic Piercing Device

An automatic piercing device attached to the gripper is optionally available; this opens the lids of aluminum crucibles shortly before the measurement starts.

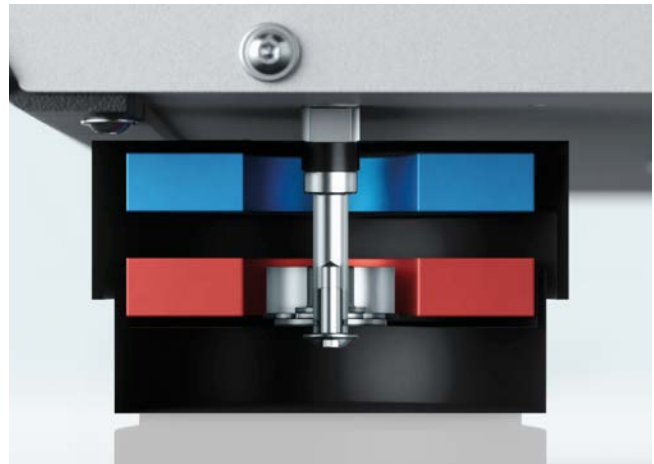

Magnetic Shock Absorbers in the Device Base

The standard feet on the STA 509 *Jupiter*® series can be optionally replaced with a patented magnetic levitation system that effectively shields the instrument from external disturbances such as vibration. This feature provides reliable results that are unaffected by environmental fluctuations.

Hydrogen Research

WITH THERMAL ANALYSIS

Hydrogen (H₂) is gaining attention for its potential role in sustainable practices and green technology. Research into the interaction of materials with hydrogen is critical for developing eco-friendly solutions that can significantly reduce environmental impact. One notable application is the use of hydrogen to mitigate high CO₂ emissions from metallurgical processes through direct reduction, such as in iron ore reduction.

The *H₂Secure* concept developed by NETZSCH features a complete solution for conducting tests in environments with varying concentrations of hydrogen while providing utmost safety. This flexibility is achieved through a comprehensive safety protocol embedded in the system, enabling seamless performance of complex oxidation-reduction cycles and precise analysis of reaction kinetics and material behavior under different conditions.



Set up

- 1 Hydrogen Gas Supply**
Hydrogen can be supplied from an H₂ generator or H₂ cylinder and is connected to the special H₂ gas inlet on the rear of the STA with integrated safety valves.
- 2 Optimized Gas Path**
This provides a precise concentration of gas, e.g., up to 100% hydrogen, while maintaining a protective gas atmosphere at the balance.
- 3 Continuous Monitoring of Gas Concentrations**
STA exhaust gas flow is monitored for H₂ and O₂ concentration.
- 4 *H₂Secure* Box**
Central communication box to control signals and allow or deny gas flows depending on the H₂ or O₂ limits defined.

The STA 509 Jupiter[®]
H₂ Safety Standards

Defined H₂ Gas Volume

Hydrogen enters at the top of the furnace. H₂ is confined to a defined space above the continuously purged balance chamber.



H₂Secure Box

The central communication box receives gas concentration information and allows or denies gas flow based on set limits.

Monitoring of H₂ and O₂

H₂ and O₂ gas concentrations are continuously measured to ensure safe handling.

Fail-Safe Security

In the case of a power failure, magnetic valves open up and release inert gas, which removes hydrogen from the system.

The Reversible Nature of Copper (Cu) – Copper Oxide (CuO) Redox Reaction

The example illustrates a cycle experiment exploring the reversible reaction of CuO with hydrogen and air by monitoring the mass changes throughout the process. Initially, CuO undergoes reduction in an H₂ atmosphere, leading to the formation of metallic Cu. Subsequently, in an oxidizing environment, metallic Cu oxidizes again to CuO with the introduction of air. In the following cycles, an increasing loss in the oxidation potential can be observed, indicating degradation of the catalytic capability.

With the help of thermogravimetry, researchers are able to gain insights into reaction kinetics, mechanisms and the thermodynamic properties of oxide-based catalysts, advancing the understanding and optimization of catalytic systems.

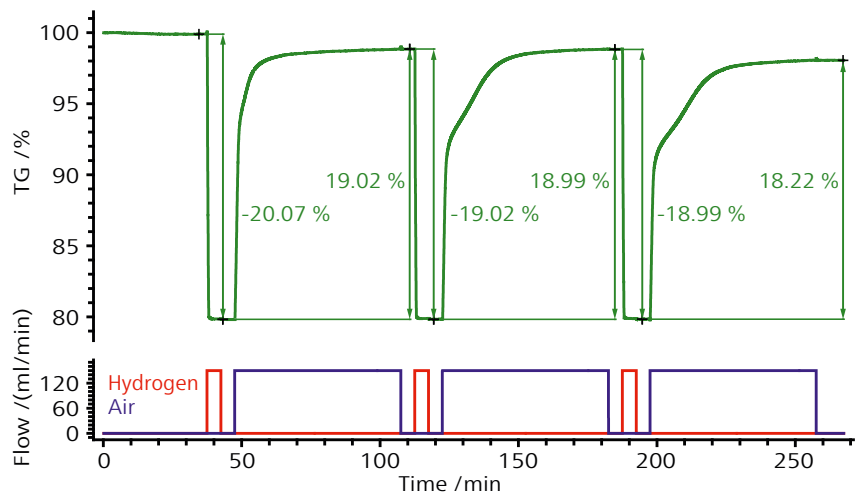

Measurement on copper oxide powder (29.975 mg) at 500°C in an alternating hydrogen/air atmosphere

STA 509 Jupiter[®] with Proteus[®]

OUR POWERFUL ANALYTICAL SOFTWARE

AutoEvaluation – Fast and Objective Results Right After a Measurement

AutoEvaluation is the industry's first self-operating evaluation system for TGA and DSC analyses. It automatically evaluates significant mass changes, endo- or exothermic reactions, generates DTG curves, and identifies peak temperatures without user input. It provides real-time, post-measurement display of evaluated curves and allows customization of detection settings and displayed results. Offering time efficiency and objectivity, *AutoEvaluation* benefits both novice and expert users. An example application is the thermal analysis of $\text{CuSO}_4 \cdot 5\text{H}_2\text{O}$, showing a water release below 300°C , decomposition of CuSO_4 between 550°C and 800°C , and reduction of CuO to Cu_2O above 800°C .

Identify – The Database for Material Identification and Quality Control

Identify is a unique software tool in the field of thermal analysis for the identification and classification of materials. The included NETZSCH libraries contain more than 1300 entries from the application areas of polymers, organics, pharmaceuticals, food, cosmetics, inorganics, ceramics, metals and alloys. Signal types currently supported include DSC, DSC c_p , TGA, TGA-c-DTA[®], STA, DIL/TMA and DMA. Users can expand the database with libraries containing an unlimited amount of their own data. Ultimately, this growing collection of database entries and measurement conditions can also be extremely useful in preparing future experiments.

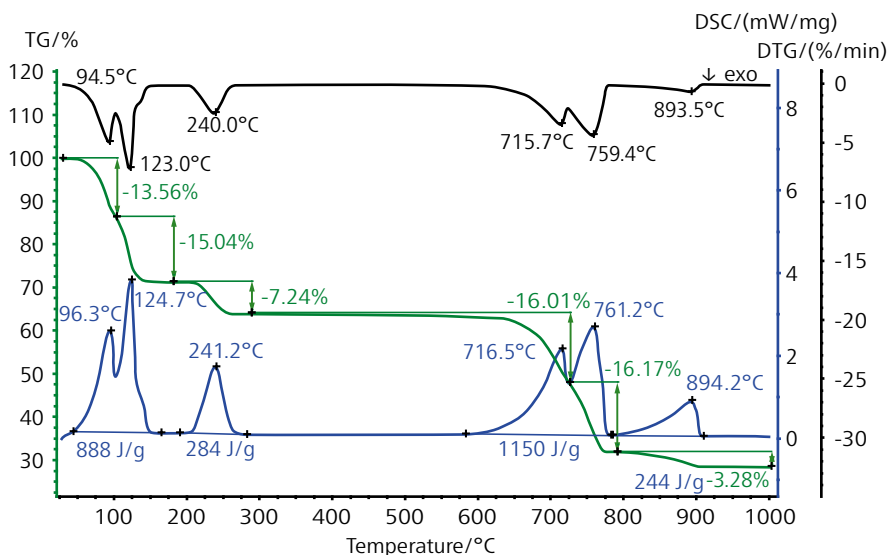

STA measurement on $\text{CuSO}_4 \cdot 5\text{H}_2\text{O}$ (13.72 mg) applying a heating rate of 10 K/min, N_2 atmosphere (70 ml/min) and PtRh crucibles with pierced lids; DTG curve (black) was created and all evaluations were performed by *AutoEvaluation*

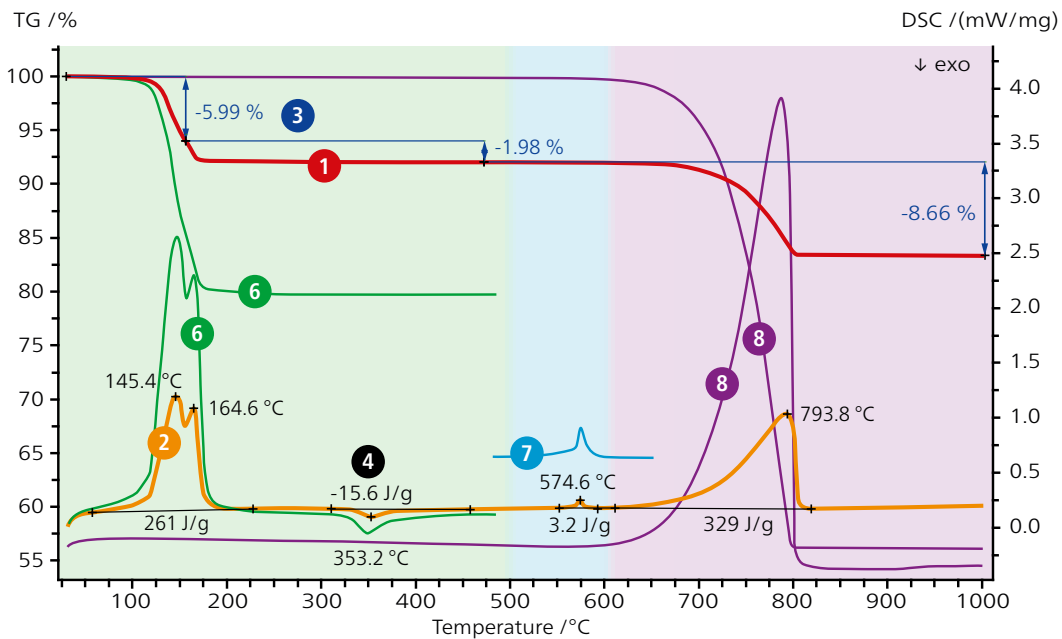

- 1 TGA measurement curve of unknown material
- 2 DSC measurement curve of unknown material
- 3 AutoEvaluation of TGA measurement
- 4 AutoEvaluation of DSC measurement
- 5 Identify results (best hits in selected ranges)
- 6 TGA-DSC comparison curves from *Identify* database
- 7 DSC comparison curve from *Identify* database
- 8 TGA-DSC comparison curves from *Identify* database

5	Measurement/ Literature Data	Similarity [%]
	gypsum_dihydrate_STA	99.2
	quartz_DSC	96.7
	CaCO3_STA	99.8

It is particularly advantageous that *Identify* can even simultaneously incorporate two types of measurements, such as TGA and DSC or *c-DTA*[®], during identification¹. As shown in the example above, analysis with *Identify* in the temperature range below 500°C reveals that the TGA-DSC results are very similar to those found for gypsum (dihydrate, CaSO₄·2H₂O) in the database. The DSC peak detected at 575°C, which is due to the structural α→β transition of quartz, occurs also in the most similar database curve in that temperature range. Above 600°C, the best hit from the database search is a measurement showing the decomposition of calcium carbonate. In summary, the investigation showed that the unknown material consists of gypsum, quartz and calcium carbonate.

¹ A. Schindler, M. Doedt, S. Gezgin, J. Menzel, S. Schmölzer, *J Therm Anal Calorim* (2017) 129:833–842, DOI 10.1007/s10973-017-6208-5

Proteus[®] Search Engine and LabV[®]

Proteus[®] Search Engine – Smart Data Management

When working with measurement and evaluation data for different materials and different measurement setups, it is enormously helpful to be able to directly access and sort data by certain criteria. *Proteus[®] Search Engine* automatically synchronizes with selectable directories and filters your data in a matter of seconds. Previews of measurement curves or analysis states are available with just one click.

Users are able to create individual searches, for example “MyCeramics”, and switch easily between different existing searches. This makes *Proteus[®] Search Engine* a very powerful data management tool.



Advantages of Proteus[®] Search Engine

- Efficient data management
- Directly access and sort data by criteria
- Quickly view measurement and analysis previews without opening files
- Retrieve data quickly and easily
- Search, e.g., by instrument name, method, operator, file and signal type, date, measurement conditions or evaluated effects

LabV[®] – Take Advantage of AI in the Lab

NETZSCH instruments are compatible with the LabV[®] data management platform, a user-friendly software solution that automates data collection, regardless of the method or device, and provides a centralized view for organizing, analyzing, and exploring your data. LabV[®]'s AI-powered digital assistant simplifies data analysis, allowing labs to easily find insights with no effort. It uses natural language processing, similar to ChatGPT, making it easy for labs to create visualizations, spot trends, and uncover complex correlations with straightforward commands.

Advantages of LabV[®]

- **Digital Workflows**
Streamline your testing process with automated workflows and a highly intuitive interface.
- **Data Platform**
Connect all your testing devices and IT systems for complete end-to-end process integration.
- **AI-Powered Digital Assistant**
The first data platform to offer laboratories access to AI by using natural language



ADDITIONAL SOFTWARE CAPABILITIES

BeFlat® – An Intelligent Way to Save Time

This software feature provides the appropriate TGA and DSC corrections for the selected measurement conditions without having to carry out a blank value determination in the form of a correction measurement.

Report Generator

Several report examples are included as templates to easily create an own report with the possibility to add company logos, tables, description fields and plots. Also Identify searches can be attached.

Peak Separation

For experimental curves exhibiting overlapping effects (TG, DSC, MS, FT-IR), our software allows for the separation of such peaks. It facilitates the presentation of experimental data as a sum of individual peaks and enables analysis of each peak separately.

Specific Heat Capacity c_p

From the DSC signal, the specific heat capacity $c_p(T)$ can be calculated based on ratio and stepwise methods that are in accordance with ASTM E1269, DIN 51007 or DIN 11357-4 standards, but also directly and automatically from the DSC heat flow in accordance with DIN 51007. The $c_p(T)$ results can be shown together with uncertainty margin curves.

Kinetics Neo – Process Optimization by Prediction

Kinetics Neo creates kinetic models of chemical reactions and physical processes based on a series of measurements under different temperature conditions. Even multi-step processes can be precisely modeled by determining kinetic parameters such as activation energy, pre-exponential factor, and order of reaction. Thus, Kinetics Neo can be used to predict the behavior of chemical systems under user-defined conditions for process optimization.

Proteus® Protect

The software option is in line with 21 CFR Part 11 and offers full data integrity.

Software Features			
	Classic	Select	Supreme
AutoEvaluation (TGA & DSC)	■	■	■
BeFlat®* (TGA & DSC)	■	■	■
c-DTA®	■	■	■
OIT Oxidation Induction Time/Temperature	■	■	■
Report Generator	■	■	■
Eco Mode	■	■	■
Identify	□	□	■
Proteus® Search Engine	□	□	■
Peak Separation	□	□	■
Specific Heat Capacity (c_p)	□	□	■
Temperature Modulation (TGA-DSC)	□	□	■
SuperRes®	□	□	■
TauR	□	□	■
Purity (includes TauR)	□	□	□
LabV®	□	□	□
Proteus® Protect (CFR 21 part 11)	□	□	□
Kinetics Neo	□	□	□
Termica Neo**	□	□	□
EGA support	□	□	□

■ included

□ optional

* included when MFC is selected

** requires Kinetics Neo

More features on request.



Measurement Update in Passing – LED Status Bar

The STA 509 *Jupiter*® features an LED light bar that allows the status of your instrument to be checked as you walk by, with different colors representing different statuses. It is reassuring to see from afar, without having to log into your PC, that your measurement is running smoothly and to be able to read instrument status notifications such as:

- Instrument is ready
- Measurement is running
- Measurement progress
- Heating/cooling to setpoint
- User interaction needed
- A problem occurred

Improving Your Productivity and Workflow Using the User Interface

The integrated color display allows you to start a measurement that was previously prepared in the NETZSCH *Proteus*® software. Just touch the prepared measurement button on the display and you will be informed about the setup of the measurement. This moves the final check before you start a new measurement directly onto the instrument.

The color touch display offers the ability to:

- Start measurements by the touch of a finger
- Check recently finished measurements
- See the progress of your measurement and time remaining
- Check current temperature
- Check and change gas flow and gas types
- Tare balance signal directly on the display
- Start and check *AutoVac* cycles
- Monitor the pressure level of the balance vessel

The STA 509 *Jupiter*[®] Placing Instrument Control and Information Directly Onto the Instrument



Supervising your measurement made easy: monitor measurement progress, control and configure setpoint and gas flow

AutoEvaluation: Objective Results Available After the Measurement Has Finished

If *AutoEvaluation* has been activated in the measurement setup, the measurement data will be evaluated immediately and objectively within the blink of an eye. An evaluation of the measurement curve will be available in an analysis window after the measurement has finished. The original plot will still be accessible.

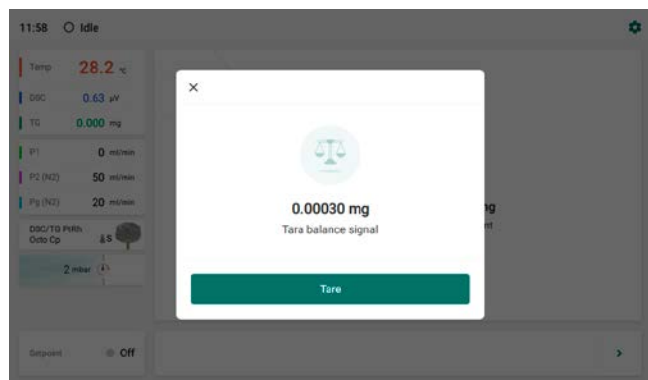

Taring the STA balance signal without having to log into the computer

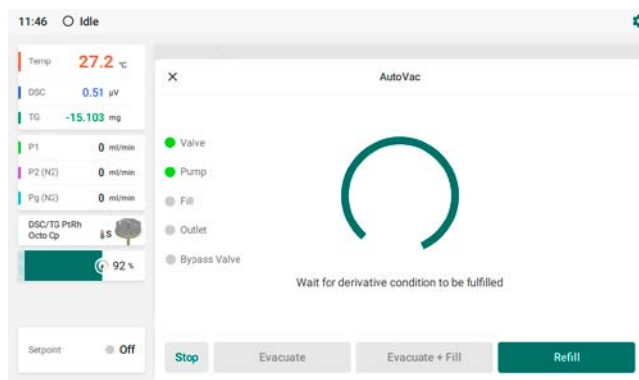

Information about the *AutoVac* process is clearly displayed on the instrument

EVOLVED GAS ANALYSIS (EGA) EXTENSIONS FOR THE STA 509 *Jupiter*®

By coupling gas analysis techniques such as FT-IR (Fourier Transform Infrared), MS (Mass Spectrometry) or GC-MS (Gas Chromatography – Mass Spectrometry) to an STA 509 *Jupiter*®, information about the nature of the evolved gases as a function of time or temperature can be obtained, providing a fingerprint of the material being analyzed.

Coupling to FT-IR

“More than just the sum of its parts” is the slogan for our comprehensive coupling system incorporating an FT-IR (Fourier Transform Infrared) spectrometer manufactured by our collaborative partner, Bruker Optics.

The purge gas flow from the TGA carries the volatiles through a short heated transfer line to the vacuum-tight gas cell of the FT-IR.

All evolved gases with a changing dipole moment are identified by their typical absorption spectrum, and complex gas mixtures can be spectroscopically separated.

PERSEUS® STA 509 *Jupiter*®

The PERSEUS® STA 509 *Jupiter*® constitutes a TGA-FT-IR system incorporating a compact Bruker Optics FT-IR spectrometer in an excellent alliance.

The design integrating the two systems has set a whole new benchmark in state-of-the-art coupling techniques. The built-in heated gas cell is directly connected with the gas outlet of the TGA furnace, and the low volume of the short transfer path enables fast transport while maintaining a small instrument footprint.

Coupling to MS

High-level material research and characterization can be achieved by coupling the STA 509 *Jupiter*® to our QMS 505 *Aëolos*® quadrupole mass spectrometer. Any gases evolved are introduced directly into the electron impact ion source of the MS through a capillary heated up to 350°C.

Coupling to GC-MS

GC-MS is a high-resolution technique for volatile and semi-volatile compounds. The gas mixtures are separated on the basis of differences in the component distribution between a stationary phase (e.g., inner coating of a capillary) and a mobile phase (purge gas; e.g., helium). A mass spectrometer serves as a detector for the gas species separated.

For detailed information,
refer to our coupling brochures.



STA 509 *Jupiter*® coupled to the FT-IR Bruker Invenio and QMS 505 *Aëolos*

APPLICATIONS

Investigation of Battery Electrolytes

Understanding the thermal behavior of battery electrolytes is critical to ensuring the performance and safety of battery systems that may carry potential hazards such as overheating and thermal runaway. The presented TGA-DSC analysis conducted under a nitrogen atmosphere on LiAsF_6 , a commonly used high-voltage electrolyte, detected a moisture impurity (1.1%) released upon heating to 150°C. Subsequent thermal treatment of the sample exhibited a solid-solid phase transition at a peak temperature of 265°C followed by the decomposition of LiAsF_6 above 350°C.

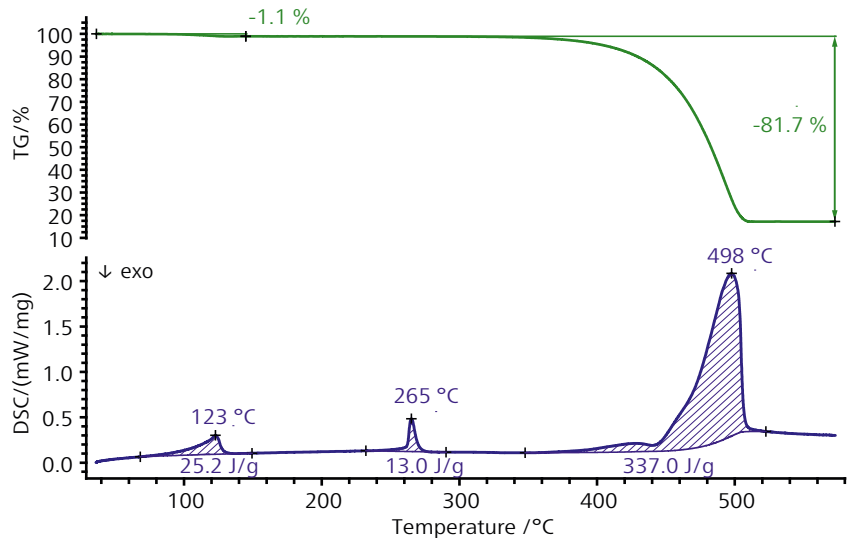

Measurement on the electrolyte LiAsF_6 (12.1 mg) in an argon atmosphere at a heating rate of 10 K/min in aluminum crucibles

Biomass Gasification with Water Vapor

The gasification process converts biomass into usable energy or important chemicals such as methanol. This example shows the gasification of walnut shell pieces at a temperature of 1200°C in pure water vapor. First, pyrolysis of the organic matter takes place, which is accompanied by the release of a complex organic gas mixture (e.g., m/z 86, 109, 137). The second step is the gasification reaction of the resulting carbon, which produces carbon dioxide (m/z 44) and hydrogen (m/z 2). The theoretical resulting carbon monoxide is superimposed by the nitrogen atmosphere.

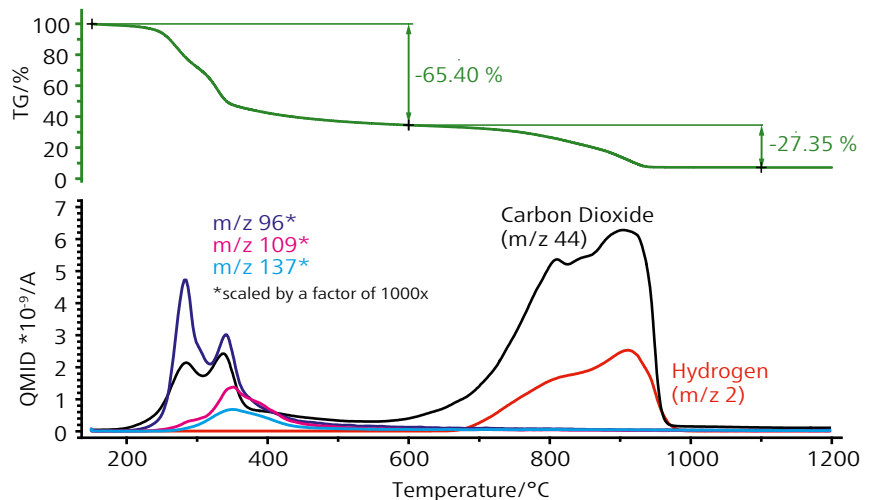

TGA-MS analysis of a crushed walnut shell (253.15 mg) at 10 K/min in a pure water vapor atmosphere

Optimization of the Burn-Out Process for a Polymer Binder

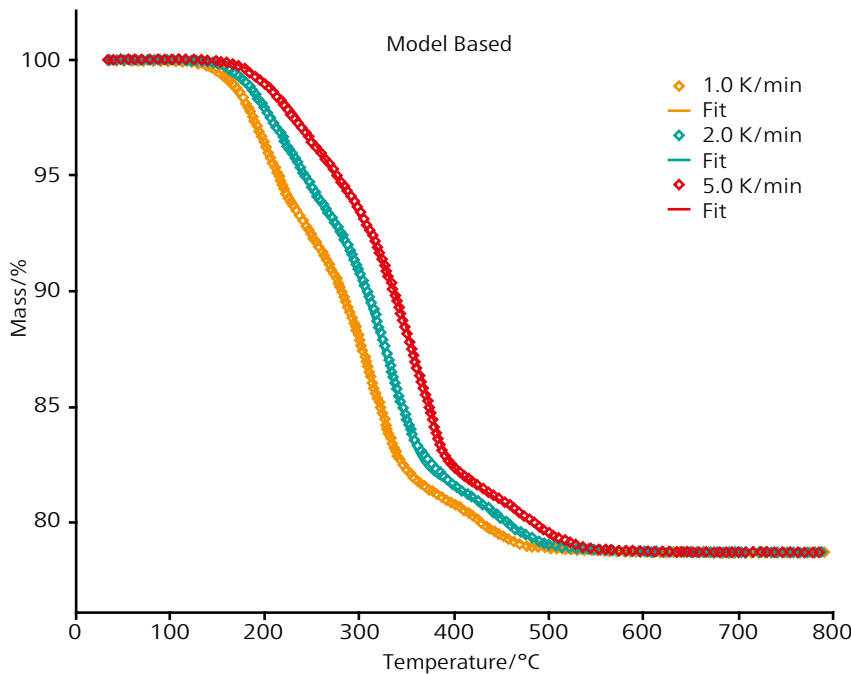

Debinding of a technical ceramic mass in an air atmosphere with different heating rates

In ceramic industry, incorporating a polymeric binder into ceramic powder enhances adhesion, a crucial element often lost in the initial stages of firing. Achieving a balance in the speed of heating is critical; gradual heating prolongs production time, whereas rapid heating risks compromising quality by triggering a surge in gas evolution during polymer decomposition. TGA analysis provides an opportunity to delve into this intricate kinetic process. By conducting analyses with varying heating rates and leveraging our proprietary Kinetics Neo software, we unlock insights crucial for fine-tuning production methods.

Meticulous Characterization – Heat Capacity and Phase Transition of Metals and Alloys

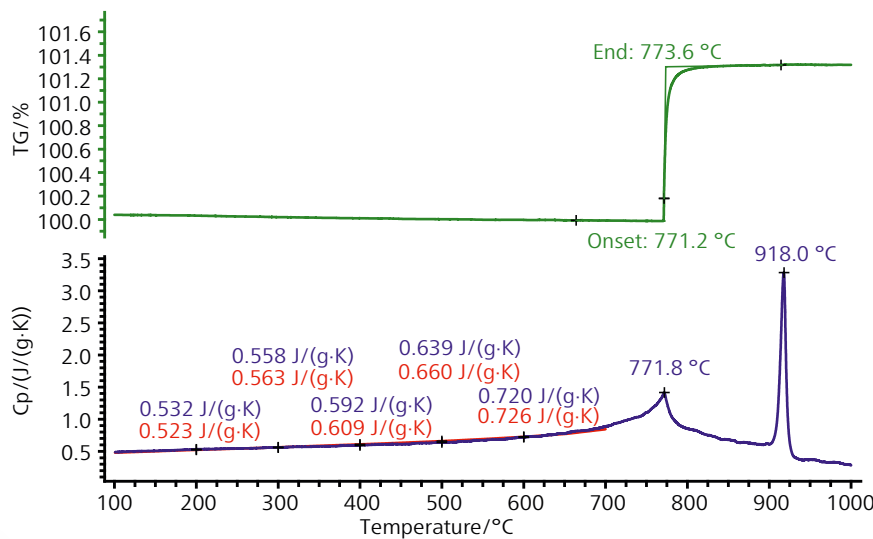

Measurement on an iron sample (121.871 mg) at 10 K/min in argon utilizing the magnetic supplement for TGA signals

This study presents a comprehensive analysis of an iron alloy, focusing on the determination of its specific heat capacity (c_p). The measured values exhibit congruence with theoretical predictions for iron up to 700°C, as depicted by the red curve. Above this temperature, an endothermic effect emerges, attributable to the Curie transition. Notably, this transition is also discernible in the thermogravimetric (TGA) signal, facilitated by the application of a magnetic field to the sample. Additionally, above 900°C, the alloy undergoes the α - γ phase transition, changing its crystal structure. These findings offer insights into the alloy's thermal properties and phase transitions; these are crucial for many industrial processes, e.g., metal casting.

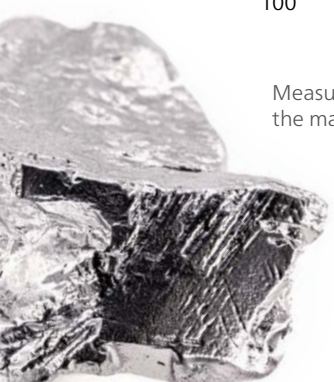

Thermal Behavior of Dental Glass Ceramic

Glass ceramics are highly attractive for dental care due to their strength, aesthetics, and biocompatibility. One means of production is the classical melting – casting – annealing process in which a precursor glass is thermally treated to initiate nucleation and crystal growth. The final crystallization takes place subsequently during firing, e.g., in a dental laboratory. The example provided illustrates the analysis of an unfired dental glass ceramic. Within the DSC signal, various effects are discernible, with particular emphasis on the exothermic crystallization (at peak 825°C). This temperature range represents the optimal process temperature to yield the most stable and dependable form of the glass ceramic, ensuring its suitability for dental applications.

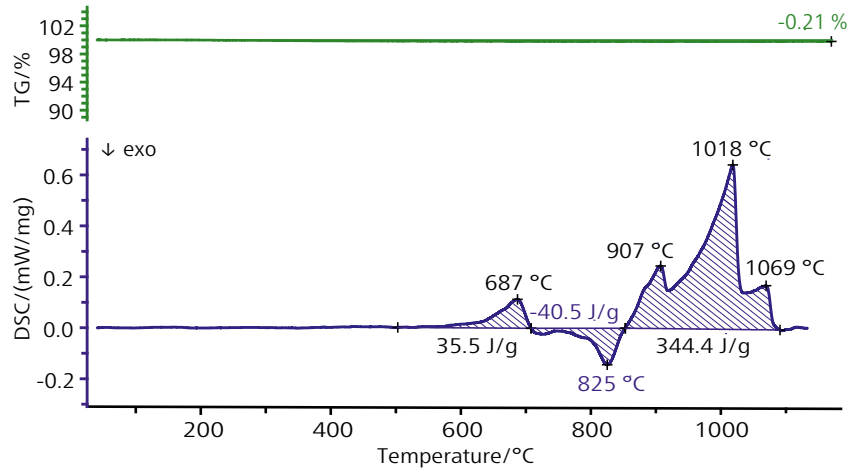

TGA-DSC measurement on a dental glass ceramic (15.462 mg) at 10 K/min in a nitrogen atmosphere

Influence of Humidity on the Crystallization Behavior of Lactose

Lactose is one of the most widespread excipients used in the pharmaceutical industry. In this study, the influence of changing humidity on amorphous lactose was investigated. Initially, only surface adsorption occurs, represented by the linear mass increase. Upon reaching the glass transition, molecular mobility increases, enabling a larger bulk water absorption. This transition marks a change in the adsorption profile. With rising humidity, the material recrystallizes, leading to a decreased mass change due to a lower water affinity of the crystalline phase.

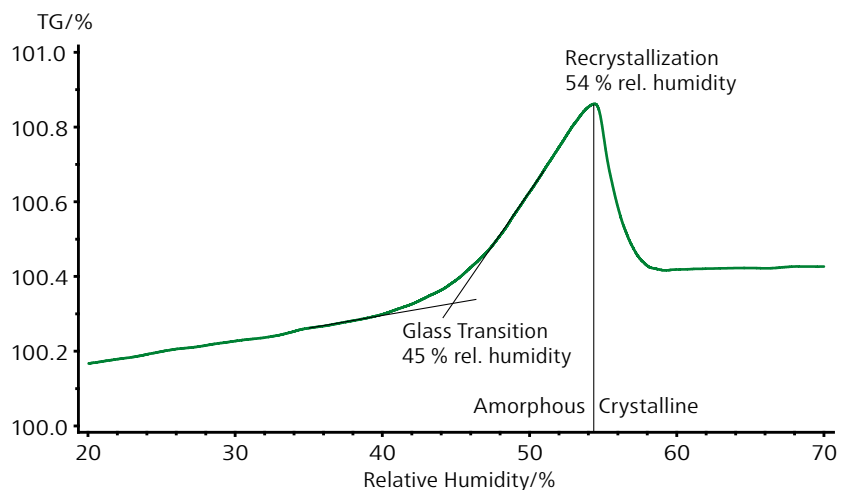

Influence of increasing humidity on a semi-crystalline lactose sample (101.23 mg) at 25°C in nitrogen

Mass Change of Polyamide 6 with Changing Humidity

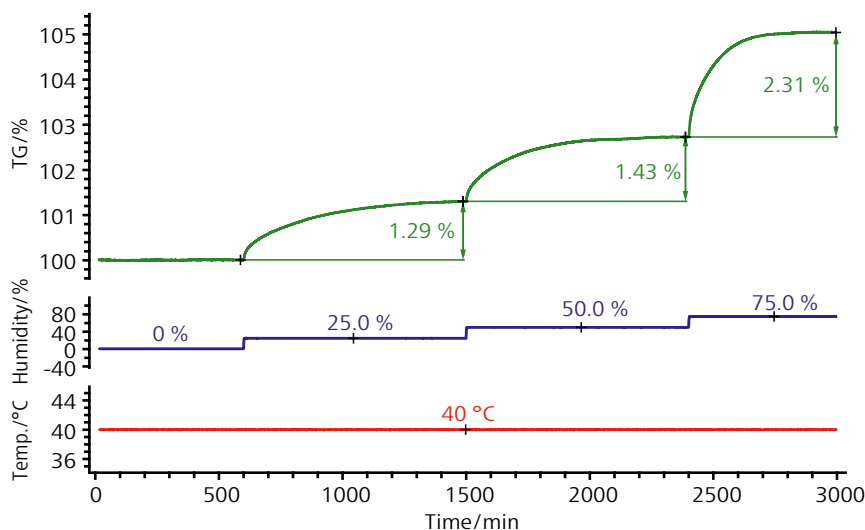

Dynamic vapor sorption test on a 250- μm -thick polyamide 6 foil under different humidity levels

Humidity plays a critical role in the properties and performance of polyamide 6 (PA6), a versatile engineering thermoplastic. For instance, it affects various properties of PA6, including mechanical, thermal, and dimensional stability. In this example, the water uptake of a PA6 foil is analyzed utilizing an STA with a special humidity setup. The resulting water uptake highly depends on the humidity level of the surrounding atmosphere; it can reach more than 5% at 40°C and a relative humidity of 75%.

Thermal Behavior of PET

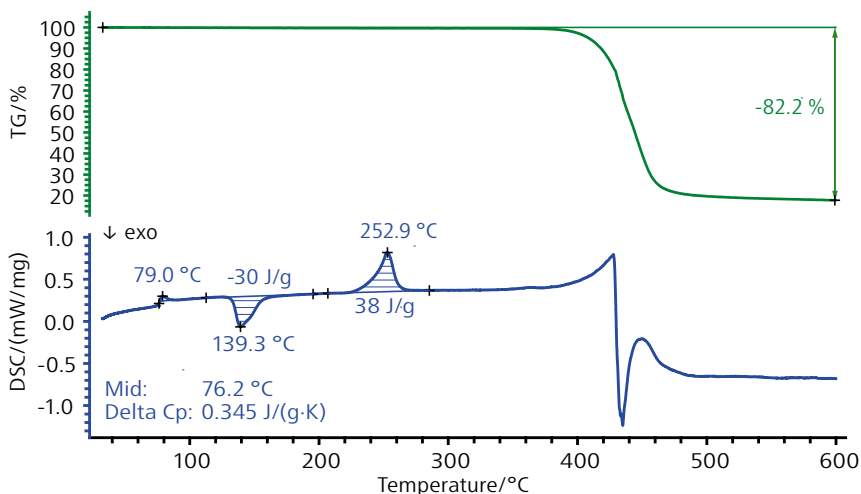

STA measurement with a SiC furnace on polyethylene terephthalate (10.121 mg) applying a heating rate of 10 K/min, nitrogen atmosphere and PtRh crucibles with pierced lids.

Plastic bottles, textile fibers and films (for example, packaging for food) are well known applications for the polymer PET (polyethylene terephthalate). This STA measurement under nitrogen shows a step in the DSC signal below 100°C due to the glass transition that is also associated with an increase in specific heat of 0.35 J/(g·K). The endothermic DSC peak at 79°C is due to relaxation; the exothermic peak at 139°C is due to crystallization; and the endothermic peak at 253°C is due to melting. At temperatures above 360°C, the pyrolytic decomposition of the sample occurred, with a total mass loss of 82.2%.



Standards

Standard*	Description
ISO 11358	Plastics – Thermogravimetry (TGA) of Polymers
ISO 11357 series	Plastics – Differential Scanning Calorimetry (DSC)
ASTM E793	Standard Test Method for Enthalpies of Fusion and Crystallization by Differential Scanning Calorimetry
ASTM D3418	Standard Test Method for Transition Temperatures and Enthalpies of Fusion and Crystallization of Polymers by Differential Scanning Calorimetry
ASTM C1470	Standard Guide for Testing the Thermal Properties of Advanced Ceramics (c_p)
DIN EN ISO 19628	Fine ceramics (advanced ceramics, advanced technical ceramics) – Thermophysical properties of ceramic composites – Determination of specific heat capacity
DIN EN ISO 22674	Dentistry – Metallic materials for fixed and removable restorations and appliances
DIN 51006	Thermal Analysis (TA); Thermogravimetry (TG); Principles
DIN 51007	Thermal Analysis; Differential Thermal Analysis; Principles

* Depending on the instrument setup



Glovebox and Hot Cell Setups

Certain materials, such as radioactive, toxic, or oxygen/moisture-sensitive substances, require special handling to ensure the operator's safety and prevent exposure to the environment. Our devices offer specialized glovebox or hot cell versions designed to meet these unique requirements, including restricted instrument handling.

Illustration shows use of glovebox with STA 509 Jupiter®, gloves are not shown

Technical Specifications

STA 509 Jupiter®			
	Classic	Select	Supreme
Design	Top-loading	Top-loading	Top-loading
Instrument interface	Illuminated information panel (optional touch display)	Touch display	Touch display
Temperature range	RT to 1600°C (sample temperature)	-150°C to 2400°C	-150°C to 2000°C
Temperature resolution	0.001 K	0.001 K	0.001 K
Furnace hoist	Motorized hoist	Motorized double hoist for two furnaces or one furnace + automatic sample changer	
Furnace	SiC furnace	Variety of furnaces incl. high-speed, water-vapor, low to highest temperature, e.g., silver, platinum, tungsten, etc.	
Heating rate	0.001 to 50 K/min	Furnace-dependent	
Sensors	<ul style="list-style-type: none"> ■ TGA ■ TGA-DTA ■ TGA-DSC 	<ul style="list-style-type: none"> ■ TGA ■ TGA-DTA ■ TGA-DSC 	<ul style="list-style-type: none"> ■ TGA ■ TGA-DTA ■ TGA-DSC
	All sensors are easily interchangeable within seconds.		
Evacuation system	Manual or software-controlled operation (<i>AutoVac</i>)		
Vacuum-tight	10 ⁻² mbar*	10 ⁻⁴ mbar*	10 ⁻⁴ mbar*
Atmospheres	Inert, oxidizing, static, dynamic, vacuum	Inert, oxidizing, static, dynamic, vacuum, corrosive (optional)	
Automatic sample changer (ASC) (optional)	20 crucible positions	20 crucible positions	20 crucible positions
Piercing device (optional)	Yes	Yes	Yes
Gas flow control	3 mass flow controllers integrated for 1 protective and 2 purge gases (optional 4 MFC)		
OTS (Oxygen Trapping System) (optional)	Yes	Yes	Yes
Balance resolution over the entire weighing range	0.1 µg	0.1 µg	0.025 µg
Maximum sample load	35 g	35 g	5 g
Balance drift	< 5 µg/hour	< 5 µg/hour	< 2 µg/hour

STA 509 Jupiter®

	<i>Classic</i>	<i>Select</i>	<i>Supreme</i>
DSC resolution (digital)	1 µW for DSC sensor type S	1 µW for DSC sensor type S	1 µW for DSC sensor type S
DSC enthalpy accuracy	1% (for indium)	1% (for indium)	1% (for indium)
Sample volume (max.)	<ul style="list-style-type: none"> ■ TGA: 10 ml ■ DSC: 0.19 ml ■ DTA: 0.9 ml 	<ul style="list-style-type: none"> ■ TGA: 10 ml ■ DSC: 0.19 ml ■ DTA: 0.9 ml 	<ul style="list-style-type: none"> ■ TGA: 5 ml ■ DSC: 0.19 ml ■ DTA: 0.9 ml
Evolved gas analysis (optional)	QMS (via capillary coupling), GC-MS and/or FT-IR couplings	QMS (via capillary coupling or direct via SKIMMER system), GC-MS and/or FT-IR couplings	QMS (via capillary coupling), GC-MS and/or FT-IR couplings
<i>PulseTA</i> ® (optional)	Yes	Yes	Yes
Special versions	–	<ul style="list-style-type: none"> ■ Glovebox version ■ Corrosion-resistant version 	<ul style="list-style-type: none"> ■ Glovebox version ■ Corrosion-resistant version

* Achievable vacuum depends on the evacuation system selected



STA 509 Jupiter® Classic with illuminated information panel

The NETZSCH Group is an owner-managed, international technology company with headquarters in Germany. The Business Units Analyzing & Testing, Grinding & Dispersing and Pumps & Systems represent customized solutions at the highest level. A worldwide sales and service network ensure customer proximity and competent service.

Our performance standards are high. We promise our customers Proven Excellence – exceptional performance in everything we do, proven time and again since 1873.

When it comes to Thermal Analysis, Calorimetry (adiabatic & reaction), the determination of Thermophysical Properties, Rheology and Fire Testing, NETZSCH has it covered. Our 60 years of applications experience, broad state-of-the-art product line and comprehensive service offerings ensure that our solutions will not only meet your every requirement but also exceed your every expectation.

Proven Excellence. ■

NETZSCH-Gerätebau GmbH
Wittelsbacherstraße 42
95100 Selb, Germany
Tel.: +49 9287 881-0
Fax: +49 9287 881-505
at@netzsch.com
www.analyzing-testing.netzsch.com



Traunstraße 21, A-2120 Wolkersdorf
T: +43 2245 6725 F: +43 2245 559633
office@prager-elektronik.at
www.prager-elektronik.at



NETZSCH®

www.netzsch.com